

1K46

Broyeur déchiqueteur
industriel

Industrial shredders

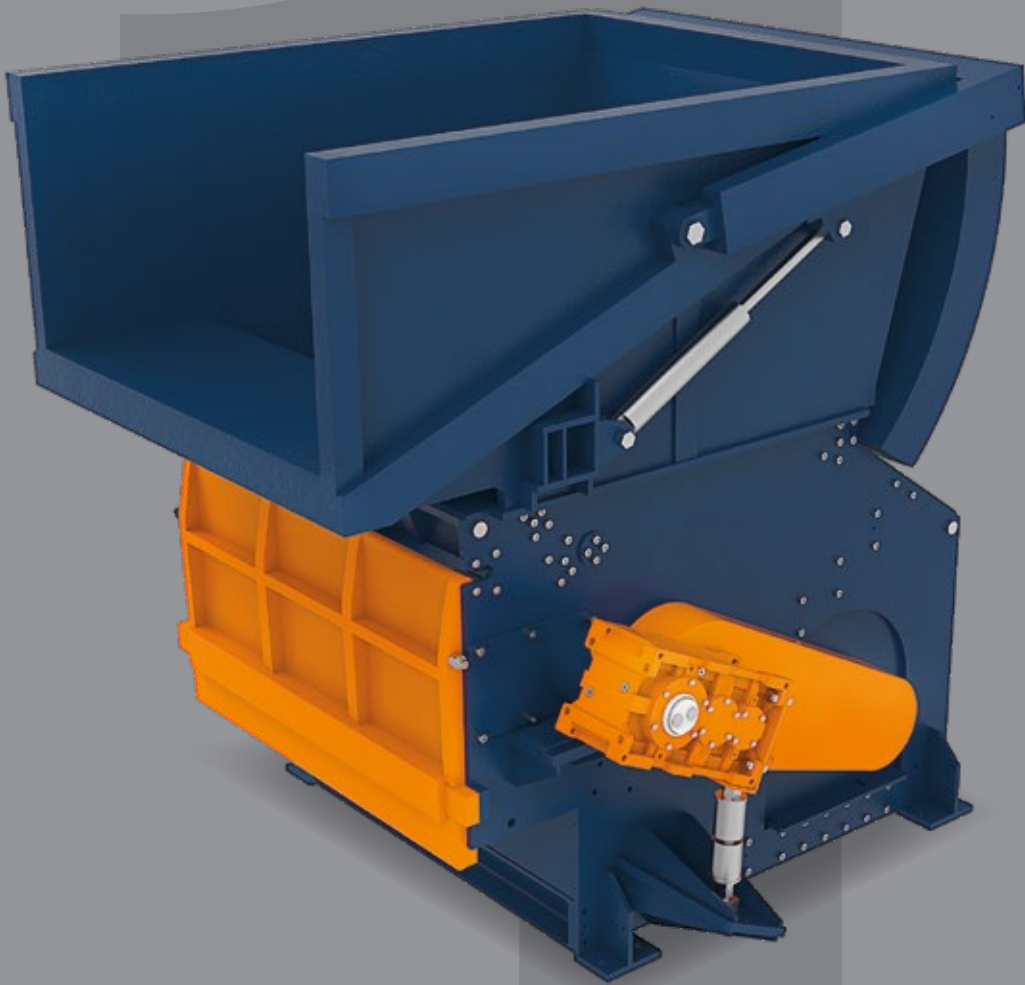

Monorotor à grille / Moteur Électrique

Single shaft / Electric drive

75 ÷ 111 kW

ISIGRANTech

Partenaire intégrateur pour la France

SatrinTech
Shredding Solutions

1K46

Made in Italy 

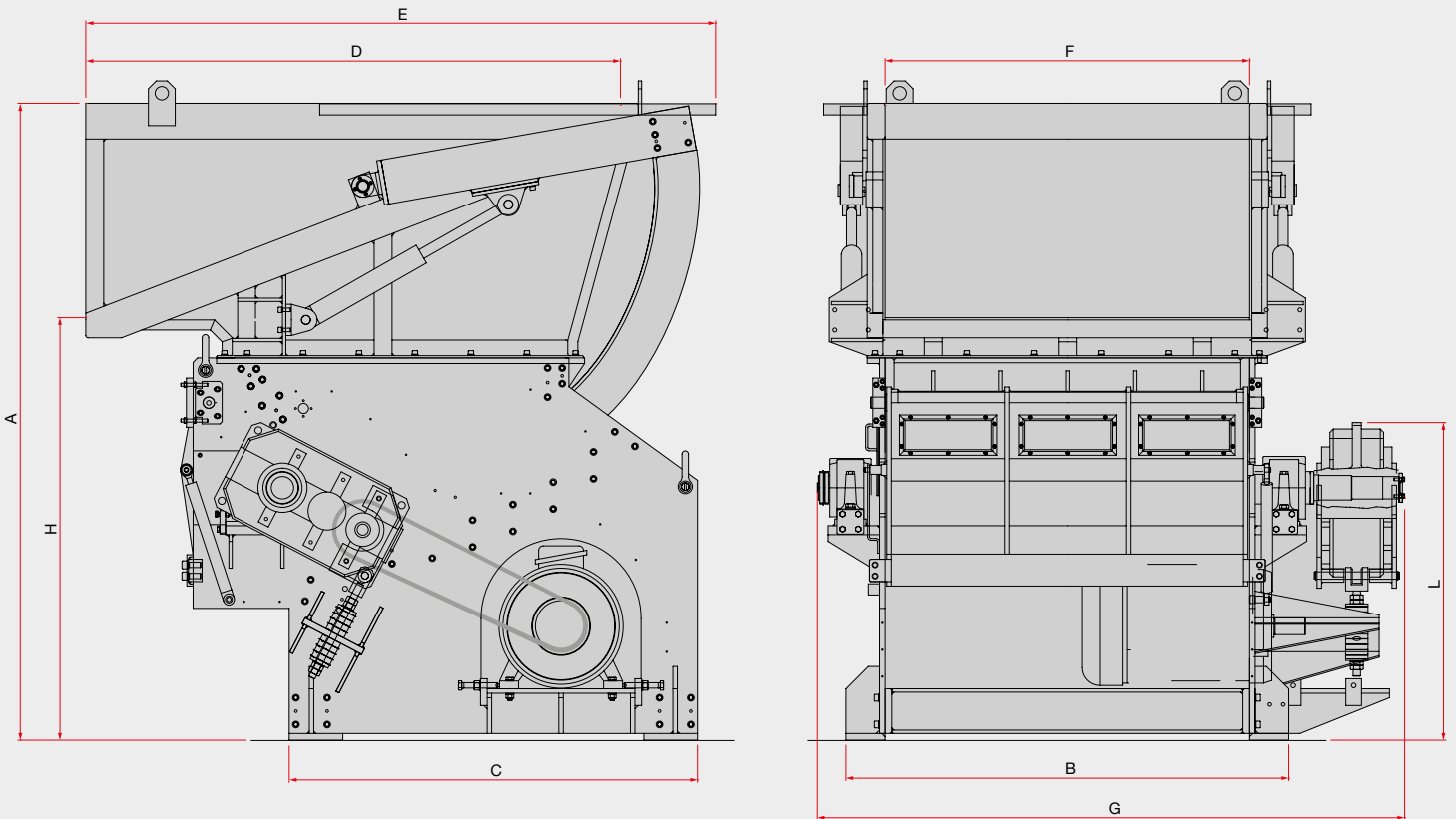





Dimensions - Dimensions

Modèle Model	A mm	B mm	C mm	D mm	E mm	F mm	G mm	H mm	L mm
1K46/150-100	2850	1980	1825	2390	2820	1630	2830	1890	1420
1K46/200-150	2850	2520	1825	2390	2820	2170	3370	1890	1420

Données techniques - Technical

Modèle Model	Chambre de broyage Shredding chamber	Ø rotor Ø rotor	Arêtes Plates	Puissance Power	Poids Weight
1K46/150-100	1630x1200 mm	460 mm	50x50x35 mm	75 kW	8200 kg
1K46/200-150	2170x1200 mm	460 mm	50x50x35 mm	111 kW	11000 kg

Applications - Applications

	Câbles électriques Electric cables	600-1000
	Déchets hospitaliers Hospital waste	800-1500
	Plastique Plastics	1000-1500
	Bois Wood	800-1200
	Papier Paper	800-1500
Matériaux - Material		kg/h